

# Dual Row Offset Micro Strip

## PSM-FF LAYOUT

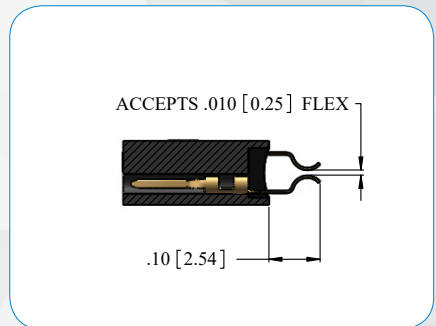
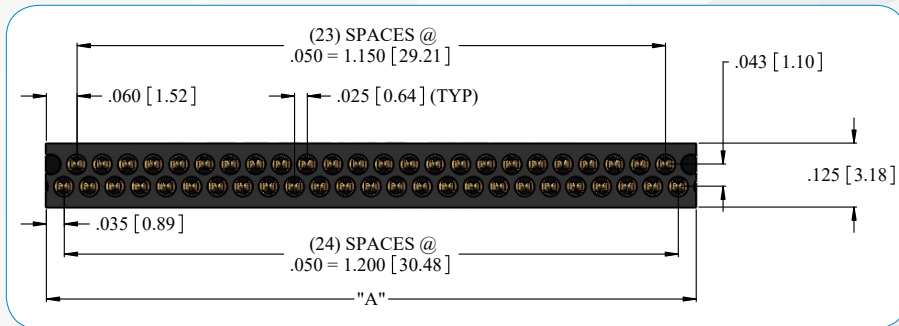
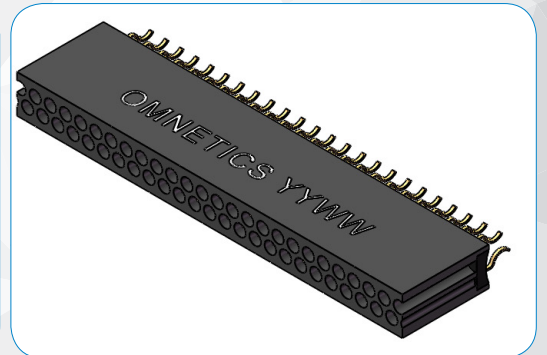
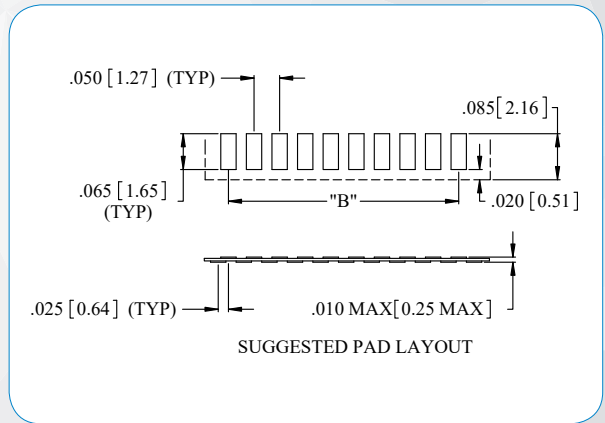
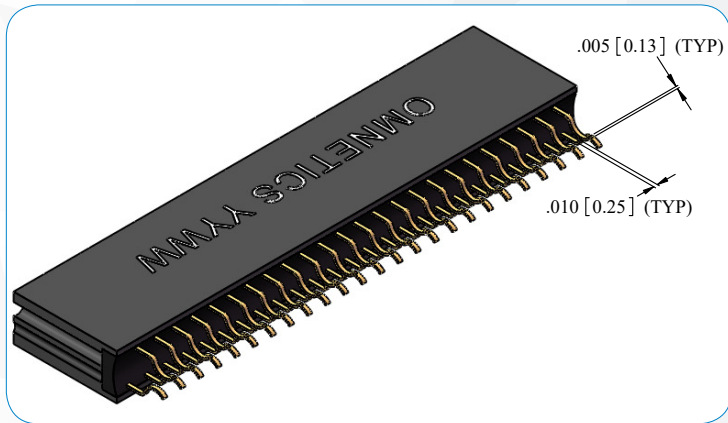

### DIMENSIONS FOR "A"

To determine connector length "A":	
Add the total number of contacts	_____
Add 1 contact cavity for each latch	_____
Add 1 contact cavity for each guide post	_____
Total contact cavities	_____
Multiply the number of contact cavities minus 1 by .025"	_____
Add .150" for each mounting hole	_____
Add fixed end length constant	.070"*
Total Length (Dimension A)	_____

Notes: Maximum length 2.47" (62.74) without mounting holes. Maximum length 2.77" (70.36) with two end mounting holes. Maximum number of contact cavities is 97. Number of contacts must be reduced to accommodate hardware and mounting holes.

\* Add 0.095" when an even number of contact cavities is used and the connector has mounting holes. Default locations for guide post holes and latches may be changed by customer.

### DIMENSIONS FOR "B"

To determine pad pattern layout length "B":	
Multiply the number of contact cavities minus 1 by .025"	_____
If hardware features are within the contact area:	
Add .025" for each latch	_____
Add .025" for each guide post hole	_____
Total Length (Dimension B)	_____

Notes: Maximum pad layout length 2.40" (60.96). Add .100" from center of mounting hole to first pad (if the first contact cavity is used for a guide post hole or latch, .100" dimension must be adjusted).

Dimensions in [ ] are in Millimeters unless otherwise noted and are for reference only.

# Dual Row Offset Micro Strip

## SSO-FF LAYOUT

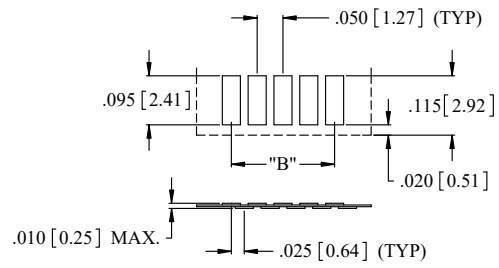
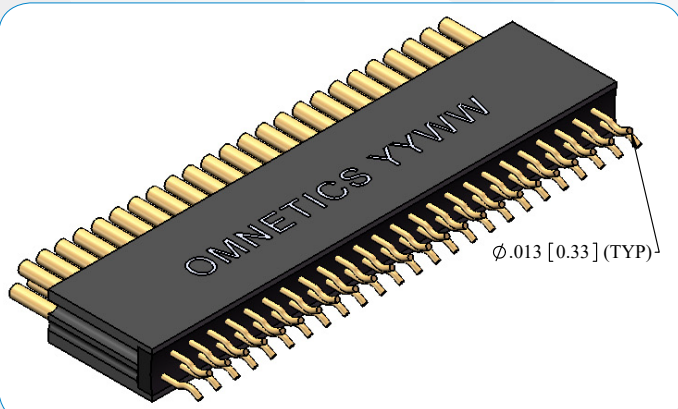

SUGGESTED PAD LAYOUT

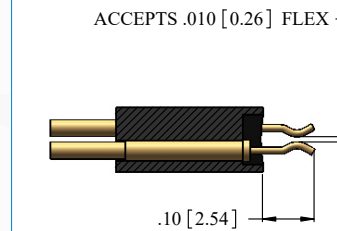
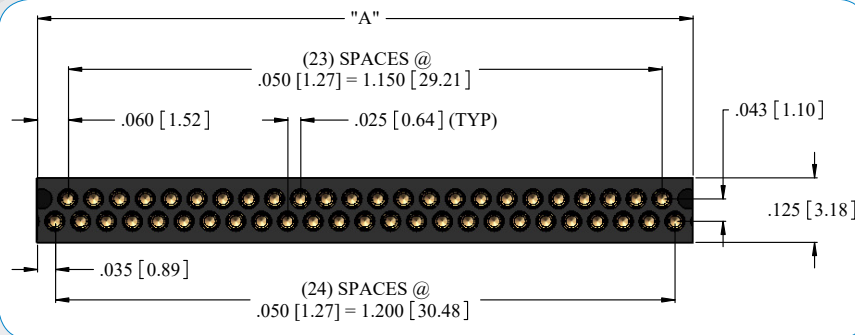
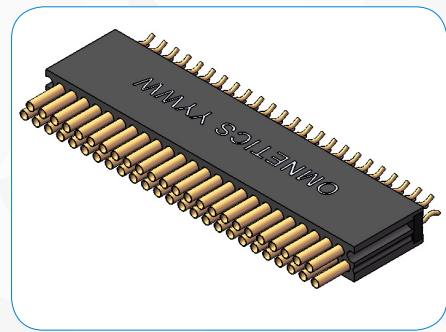
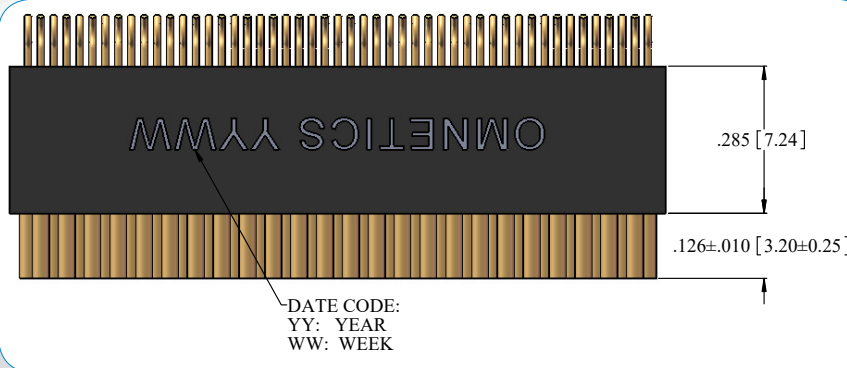

### DIMENSIONS FOR "A"

To determine connector length "A":	
Add the total number of contacts	_____
Add 1 contact cavity for each latch	_____
Add 1 contact cavity for each guide post	_____
Total contact cavities	_____
Multiply the number of contact cavities minus 1 by .025"	_____
Add .150" for each mounting hole	_____
Add fixed end length constant	.070"*
Total Length (Dimension A)	_____

Notes: Maximum length 2.47" (62.74) without mounting holes. Maximum length 2.77" (70.36) with two end mounting holes. Maximum number of contact cavities is 97. Number of contacts must be reduced to accommodate hardware and mounting holes.

\* Add 0.095" when an even number of contact cavities is used and the connector has mounting holes. Default locations for guide post holes and latches may be changed by customer.

### DIMENSIONS FOR "B"

To determine pad pattern layout length "B":	
Multiply the number of contact cavities minus 1 by .025"	_____
If hardware features are within the contact area:	
Add .025" for each latch	_____
Add .025" for each guide post hole	_____
Total Length (Dimension B)	_____

Notes: Maximum pad layout length 2.40" (60.96). Add .100" from center of mounting hole to first pad (if the first contact cavity is used for a guide post hole or latch, .100" dimension must be adjusted).

Dimensions in [ ] are in Millimeters unless otherwise noted and are for reference only.