

# Dual Row Micro Strip

## DRP-DD LAYOUT

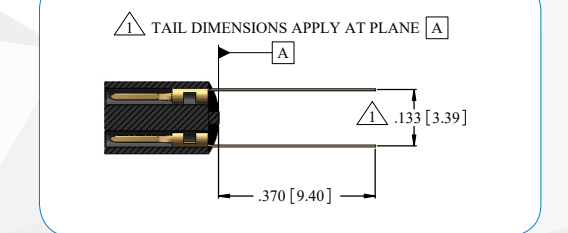
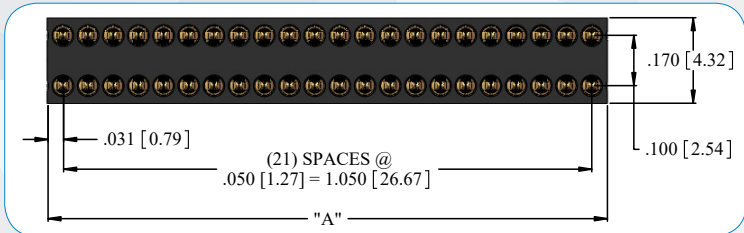
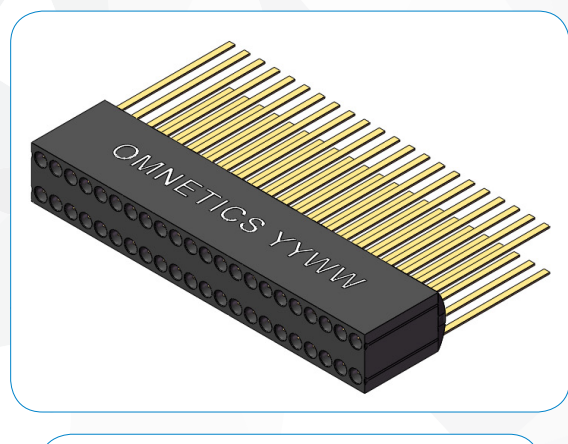
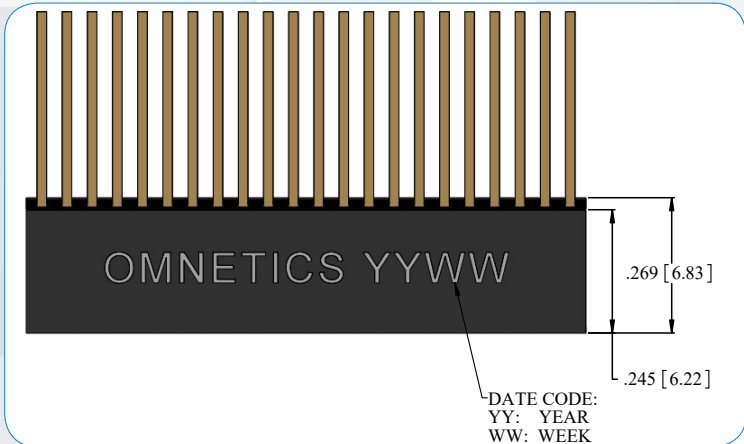
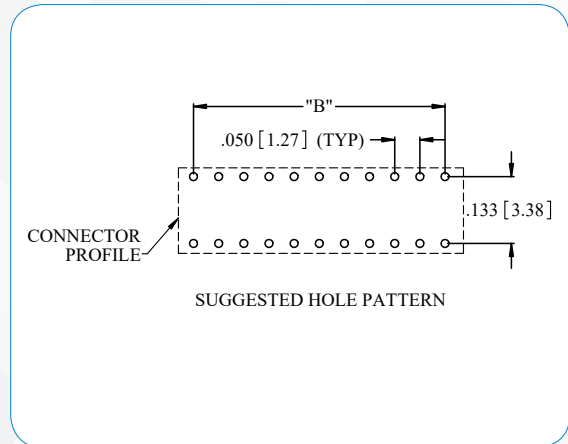
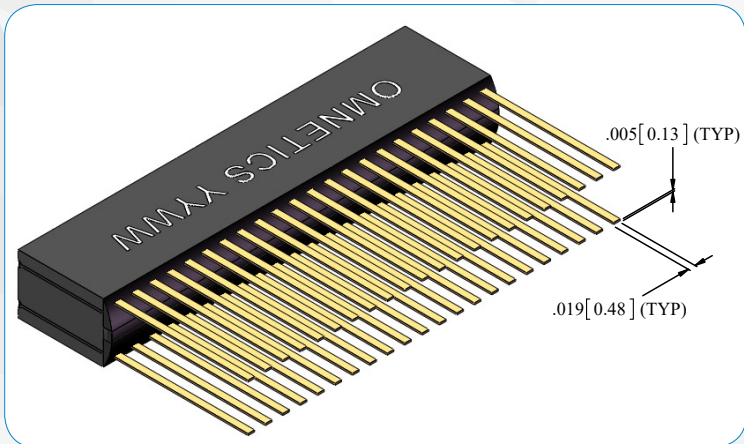

### DIMENSIONS FOR "A"

To determine connector length "A":

Add the total number of contacts in one row	_____
Add 1 contact cavity for each latch in the same row	_____
Add 1 contact cavity for each guide post hole in the same row	_____
Total contact cavities in a single row	_____
Multiply the number of contact cavities minus 1 by .050"	_____
Add .150" for each mounting hole	_____
Add .100" for each screw receptacle	_____
Add fixed end length constant	.062"
Total Length (Dimension A)	_____

Notes: Maximum length 1.85" (46.99). Maximum number of contact cavities is 64. Number of contacts must be reduced to accommodate hardware and mounting holes. Default locations for guide post holes and latches may be changed by customer.

### DIMENSIONS FOR "B"

To determine pad pattern layout length "B":

Multiply the number of contact cavities in one row minus 1 by .050"	_____
If hardware features are within the contact area:	
Add .050" for each latch	_____
Add .050" for each guide post hole	_____
Add .100" for each screw receptacle	_____
Total Length (Dimension B)	_____

Notes: Maximum length 1.55" (39.37). Add .100" from center of mounting hole to first pad (if the first contact cavity is used for a guide post hole or latch, .100" dimension must be adjusted).

Dimensions in [ ] are in Millimeters unless otherwise noted and are for reference only.

# Dual Row Micro Strip

## DRS-DD LAYOUT

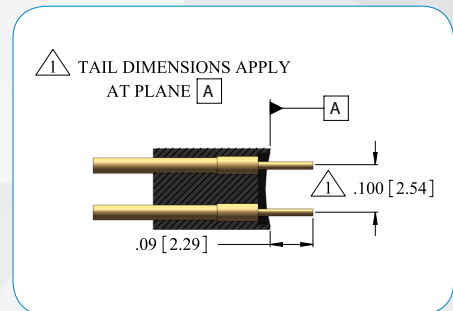
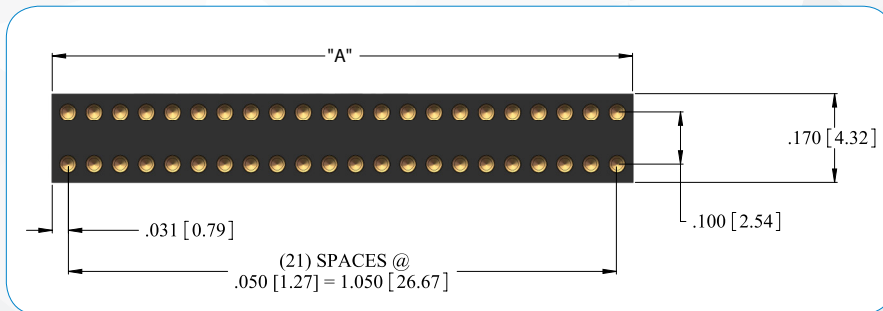
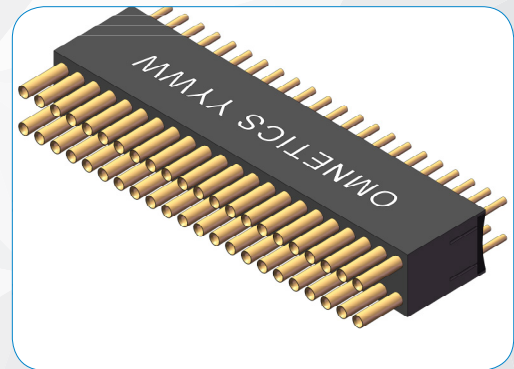
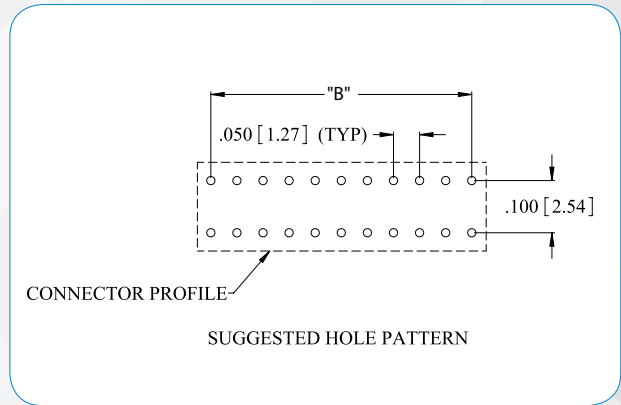
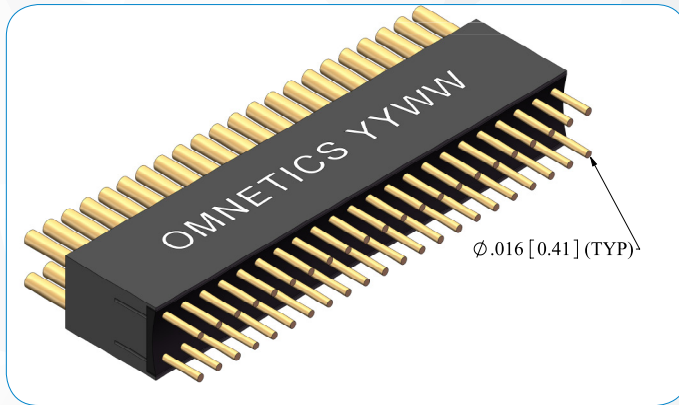

### DIMENSIONS FOR "A"

To determine connector length "A":

Add the total number of contacts in one row	_____
Add 1 contact cavity for each latch in the same row	_____
Add 1 contact cavity for each guide post hole in the same row	_____
Total contact cavities in a single row	_____
Multiply the number of contact cavities minus 1 by .050"	_____
Add .150" for each mounting hole	_____
Add .100" for each screw receptacle	_____
Add fixed end length constant	.062"
Total Length (Dimension A)	_____

Notes: Maximum length 1.85" (46.99). Maximum number of contact cavities is 64. Number of contacts must be reduced to accommodate hardware and mounting holes. Default locations for guide post holes and latches may be changed by customer.

### DIMENSIONS FOR "B"

To determine pad pattern layout length "B":

Multiply the number of contact cavities in one row minus 1 by .050"	_____
If hardware features are within the contact area:	
Add .050" for each latch	_____
Add .050" for each guide post hole	_____
Add .100" for each screw receptacle	_____
Total Length (Dimension B)	_____

Notes: Maximum length 1.55" (39.37). Add .100" from center of mounting hole to first pad (if the first contact cavity is used for a guide post hole or latch, .100" dimension must be adjusted).

Dimensions in [ ] are in Millimeters unless otherwise noted and are for reference only.