

Plastic - Pin - Straight Tail

MCP-DD

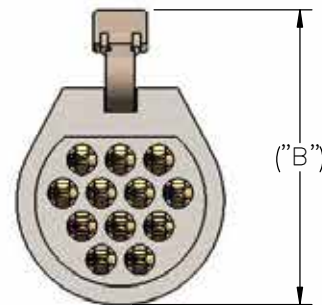
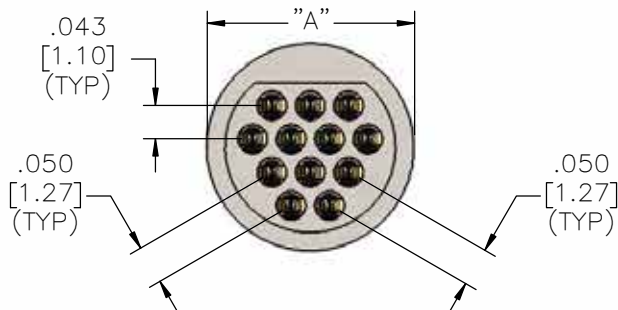
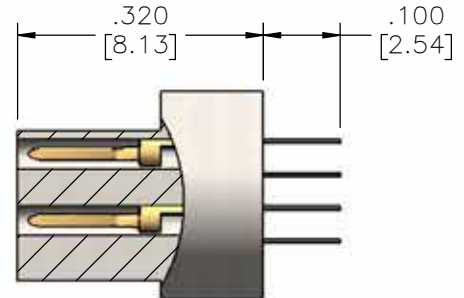

English (IN) Metric (MM)

Part #	Contacts	A	A
A22015-001	5	0.220	5.59
A22017-001	12	0.270	6.86
A22036-001	16	0.325	8.26
A22019-001	27	0.395	10.03
A22392-001	39	0.445	11.30

LATCHING OPTION

English (IN) Metric (MM)

Part #	Contacts	B	B
A22044-001	5	0.310	7.87
A22068-001	7	0.340	8.64
A22046-001	12	0.380	9.65
A22050-001	16	0.410	10.41
A22048-001	27	0.480	12.19

Plastic - Socket - Straight Tail

MCS-DD

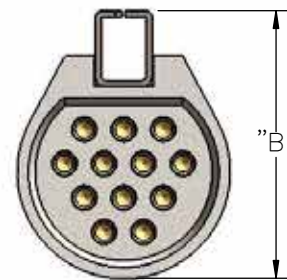
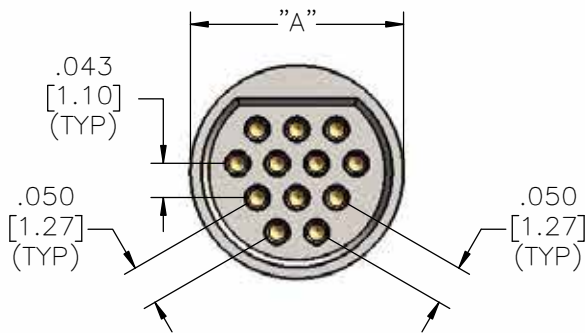
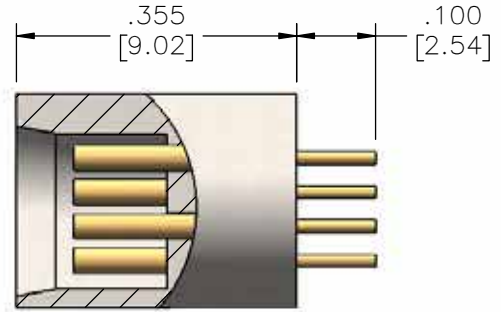
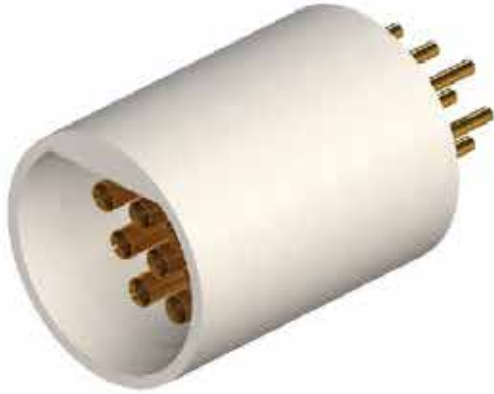

Part #	Contacts	English	Metric
		(IN)	(MM)
A22014-001	5	A	A
A22016-001	12	0.220	5.59
A22037-001	16	0.270	6.86
A22018-001	27	0.325	8.26
A22018-001	27	0.395	10.03
A22400-001	39	0.445	11.30

LATCHING OPTION

Part #	Contacts	English	Metric
		(IN)	(MM)
A22045-001	5	B	B
A22069-001	7	0.310	7.87
A22047-001	12	0.340	8.64
A22047-001	12	0.380	9.65
A22051-001	16	0.410	10.41
A22049-001	27	0.480	12.19