

MATERIALS & SPECIFICATIONS

PART NO.	A24001-008	REV	ECO	DATE	APP
		E	102048	11-03-15	TLM

INSULATOR:

POLYPHENYLENE SULFIDE (PPS)
PER MIL-M-24519, TYPE GST
40F.

CONTACT:

BERYLLIUM COPPER PER ASTM
B194, C17200. GOLD PLATED
PER ASTM B488, (HARD GOLD)
TYPE II CODE C CLASS 1.27.

TERMINATION:

SOLDER COATED WITH SN63A PER
J-STD-006 OR AMS-P-81728.

LATCH BOX:

BERYLLIUM COPPER PER ASTM
B194 NICKEL PLATE PER SAE-
AMS-2404.

CURRENT CAPACITY:

3 AMP MAX.

CONTACT RESISTANCE:

26 MILLIOHMS (65mV) MAX @
2.5 AMPS.

PERFORMANCE:

PRODUCT FAMILY TESTED TO AND
PASSED THE PERFORMANCE
SPECIFICATIONS OF TABLE VII OF
MIL-DTL-83513.

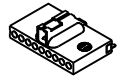

ACTUAL SIZE

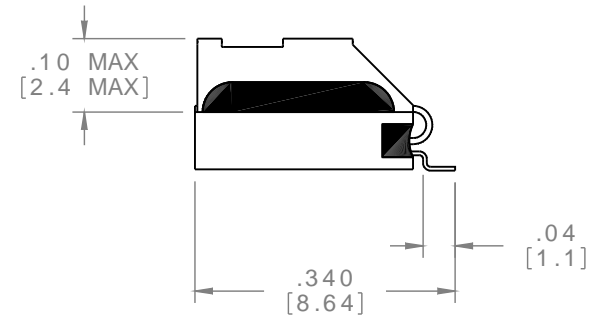
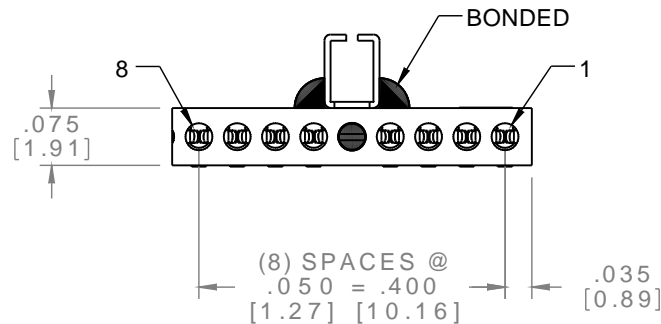
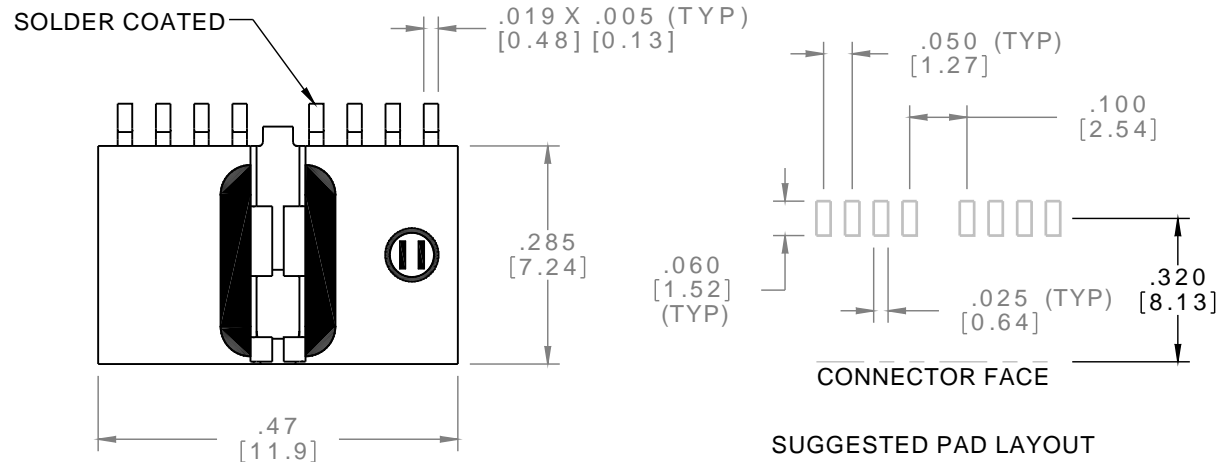

NOTE:

DIMENSIONS IN [] ARE IN
MILLIMETERS UNLESS
OTHERWISE NOTED AND ARE
FOR REFERENCE ONLY

PS1 SLDW	THIRD ANGLE
	-TOLERANCES-
	UNLESS OTHERWISE NOTED
	DIMENSIONS IN INCHES
2	PL DEC ± .01
3	PL DEC ± .005
4	PL DEC ± .0005
	ANGLES ± 1°

THIS DRAWING CONTAINS CONFIDENTIAL AND PROPRIETARY INFORMATION WHICH IS THE PROPERTY OF OMNETICS CONNECTOR CORP. THIS DOCUMENT MAY NOT, IN WHOLE OR IN PART, BE DUPLICATED, OR DISCLOSED FOR ANY PURPOSE, WITHOUT WRITTEN PERMISSION FROM OMNETICS CONNECTOR CORP.	
DFTM. DEL	DATE 09-26-02
CHK'D.	DATE
APP'D.	DATE
TITLE: (8) PIN MALE CONNECTOR W/LATCH	

OMNETICS
CONNECTOR CORPORATION
7260 COMMERCE CIRCLE EAST
MINNEAPOLIS, MN 55432
WWW.OMNETICS.COM

CAGE CODE 61873
DWG NO. A24001-008
SHEET 1 OF 1
SCALE: 4:1
REV E